

Zoom Lens

This zoom lens is designed for use with Panasonic's applicable projectors. The lens makes it possible to vary the projection distance by changing the focal distance.

**NOTE:** The lens cannot be used by itself. It must be mounted onto the specified Panasonic DLP™ projector.

**Specifications**

F value:	1.8-2.4
Focal distance (f):	19.4-27.9 mm
Throw ratio	WUXGA 1.30-1.89:1 (16:10 aspect ratio) WXGA 1.36-1.98:1 (16:10 aspect ratio) XGA 1.34-1.95:1 (4:3 aspect ratio)
Dimensions (W × H × D):	95 × 95 × 168 mm (3-3/4 × 3-3/4 × 6-5/8 inches)
Weight:	1.1 kg (2.4 lbs)
Applicable projector:	<p>Group A PT-DZ870K/DZ870LK/DZ870W/DZ870LW/DW830K/DW830LK/DW830W/DW830LW/DX100K/DX100LK/DX100W/DX100LW</p> <p>Group B PT-DZ770K/DZ770LK/DZ770S/DZ770LS/DW740S/DW740LS/DW740K/DW740LK/DW730S/DW730LS/DW730K/DW730LK/DX810S/DX810LS/DX810K/DX810LK/DX800S/DX800LS/DX800K/DX800LK/DZ680K/DZ680LK/DZ680S/DZ680LS/DW640K/DW640LK/DW640S/DW640LS/DX610K/DX610LK/DX610S/DX610LS/DZ6710/DZ6710L/DZ6700/DZ6700L/DW6300S/DW6300LS/DW6300K/DW6300LK/D6000S/D6000LS/D6000K/D6000LK/D5000S/D5000LS</p> <p>Group C PT-RZ120B/RZ120W/RZ120LB/RZ120LW/RZ970B/RZ970W/RZ970LB/RZ970LW/RW930B/RW930W/RW930LB/RW930LW/RX110B/RX110W/RX110LB/RX110LW/RZ870B/RZ870W/RZ870LB/RZ870LW/RZ770B/RZ770W/RZ770LB/RZ770LW/RW730B/RW730W/RW730LB/RW730LW/RZ660B/RZ660W/RZ660LB/RZ660LW/RW620B/RW620W/RW620LB/RW620LW/RZ670B/RZ670W/RZ670LB/RZ670LW/RW630B/RW630W/RW630LB/RW630LW</p> <p>Group D PT-DZ780B/DZ780W/DZ780LB/DZ780LW/DW750B/DW750W/DW750LB/DW750LW/DX820B/DX820W/DX820LB/DX820LW</p>

**Dimensions**

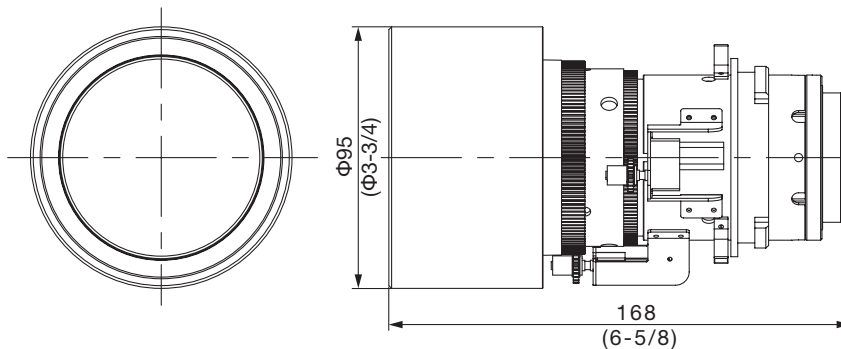
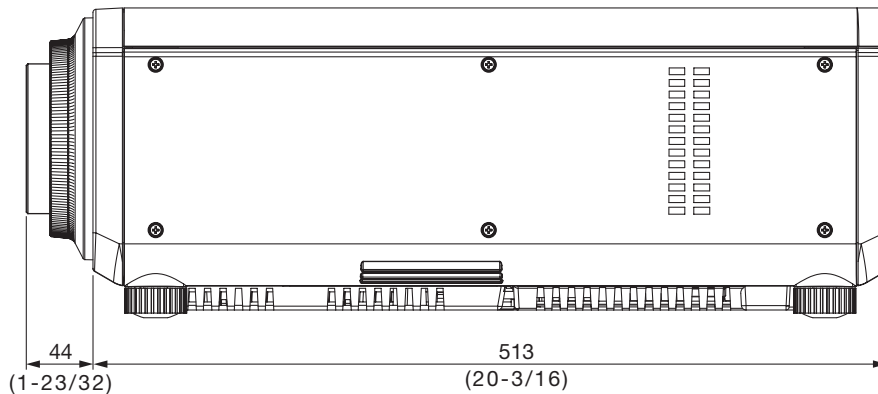

Illustration shows the lens attached to an applicable projector.

[Group A]



unit : mm (inch)

**NOTE:** This illustration is not drawn to scale.

[Group B]

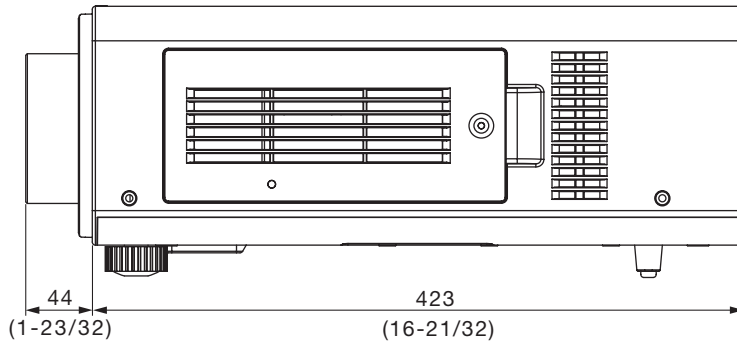

[Group C]

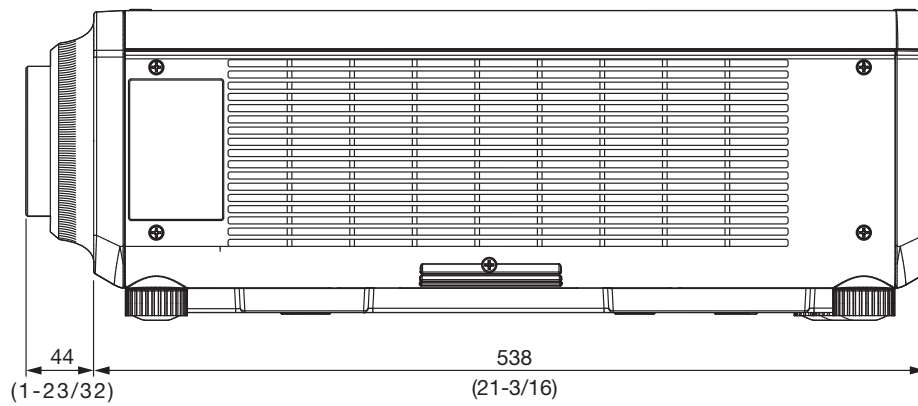

[Group D]

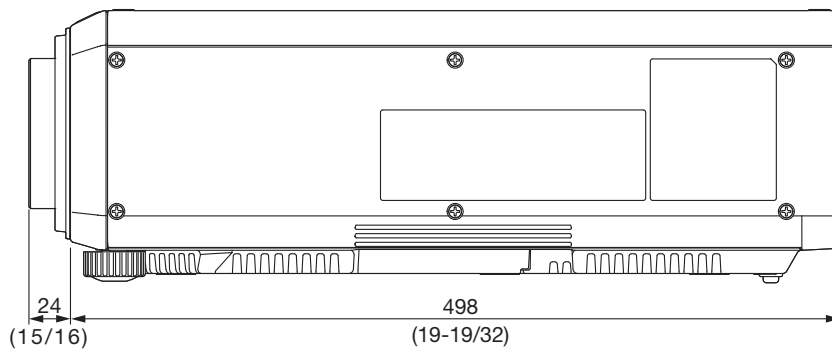

unit : mm (inch)  
NOTE: This illustration is not drawn to scale.

For information on the projection distance, refer to the specifications for the projector to which the lens will be mounted.  
DLP is a trademark of Texas Instruments. Weights and dimensions shown are approximate. Specifications subject to change without notice.